

## Single Line Bi-directional Transient Voltage Suppressor

### DESCRIPTION

The GSD05TC TVS diode is designed to replace multilayer varistors (MLVs) in portable applications such as cell phones, notebooks, and PDA's. It offers superior electrical characteristics such as low clamping voltage, low leakage current and high surge capability. It is designed to protect sensitive electronic components which are connected to power lines, from over-stress caused by ESD (Electrostatic Discharge), EFT (Electrical Fast Transients) and Lighting.

The GSD05TC is in a SOD-323 package and will protect one unidirectional line. It may be used to provide ESD protection up to  $\pm 30\text{kV}$  (Contact and air discharge) according to IEC61000-4-2, and withstand peak pulse current up to 145A (8/20 $\mu\text{s}$ ) according to IEC61000-4-5.

### FEATURES

- ✧ Transient protection for high-speed data lines  
IEC 61000-4-2 (ESD)  $\pm 30\text{kV}$  (Contact)  
 $\pm 30\text{kV}$  (Air)
- ✧ Peak power dissipation: 2080W (8/20 $\mu\text{s}$ )
- ✧ Working voltages : 5V
- ✧ Low leakage current
- ✧ Low clamping voltage
- ✧ Solid-state silicon-avalanche technology

### MACHANICAL DATA

- ✧ SOD-323 package
- ✧ Flammability Rating: UL 94V-0
- ✧ High temperature soldering guaranteed:  
260 $^{\circ}\text{C}$ /10s
- ✧ Packaging: Tape and Reel
- ✧ Reel size: 7 inch

### ORDERING INFORMATION

- ✧ Device: GSD05TC
- ✧ Package: SOD-323
- ✧ Marking: D5
- ✧ Material: Halogen free and RoHS compliant
- ✧ Packing: Tape & Reel
- ✧ Quantity per reel: 3,000pcs

### APPLICATIONS

- ✧ Power lines
- ✧ Personal digital assistants (PDA's)
- ✧ Microprocessors based equipment
- ✧ Notebooks, Desktops, and Servers
- ✧ Cell phone Handsets and Accessories
- ✧ Portable Electronics
- ✧ Peripherals

### PIN CONFIGURATION

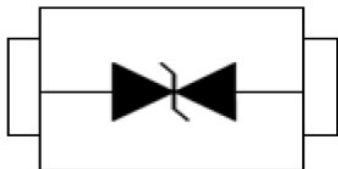

### PACKAGE OUTLINE



## Single Line Bi-directional Transient Voltage Suppressor

### ABSOLUTE MAXIMUM RATING

Symbol	Parameter	Value	Units
V <sub>ESD</sub>	ESD per IEC 61000-4-2 (Contact)	±30	kV
	ESD per IEC 61000-4-2 (Air)	±30	
P <sub>PP</sub>	Peak Pulse Power (8/20μs)	2080	W
T <sub>OPT</sub>	Operating Temperature	-55~125	°C
T <sub>STG</sub>	Storage Temperature	-55~150	°C
T <sub>L</sub>	Lead Soldering Temperature	260(10sec)	°C

### ELECTRICAL CHARACTERISTICS (T<sub>amb</sub>=25°C)

Symbol	Parameter	Test Condition	Min	Typ	Max	Units
V <sub>RWM</sub>	Reverse Working Voltage				5.0	V
V <sub>BR</sub>	Reverse Breakdown Voltage	I <sub>T</sub> = 1mA	5.3		8.0	V
I <sub>R</sub>	Reverse Leakage Current	V <sub>RWM</sub> = 5.0V			1	uA
I <sub>PP</sub>	Peak Pulse Current	t <sub>p</sub> = 8/20μs			130	A
V <sub>C</sub>	Clamping Voltage	I <sub>PP</sub> = 130A, t <sub>p</sub> = 8/20μs			16	V
C <sub>J</sub>	Junction Capacitance	V <sub>R</sub> = 0V, f = 1MHz			450	pF

### ELECTRICAL CHARACTERISTICS CURVE

Fig 1 8/20 $\mu$ s Waveform per IEC61000-4-5

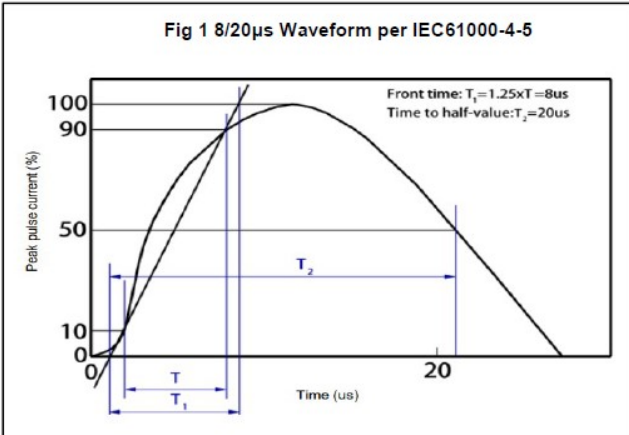

Fig 2 Contact Discharge Current Waveform per IEC 61000-4-2)

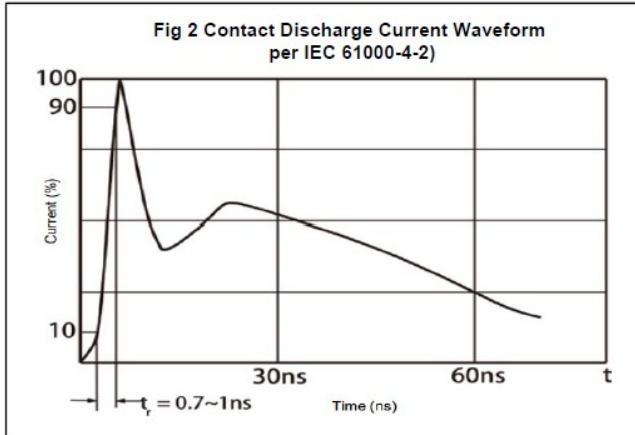

Fig 3 Voltage vs Capacitance

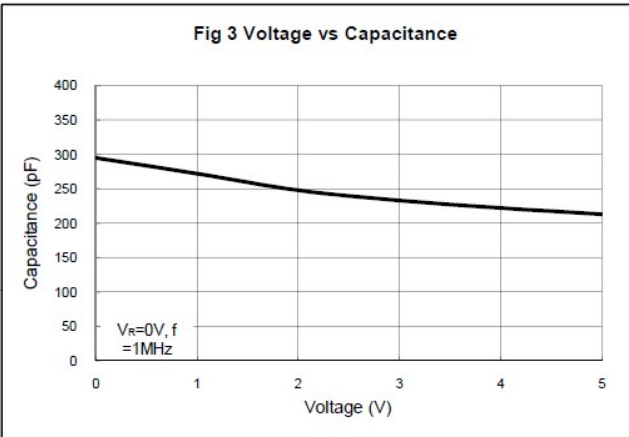
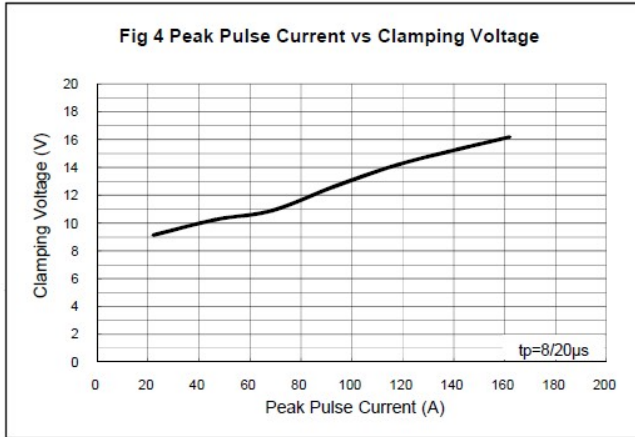
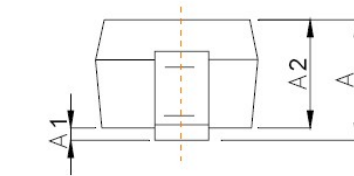
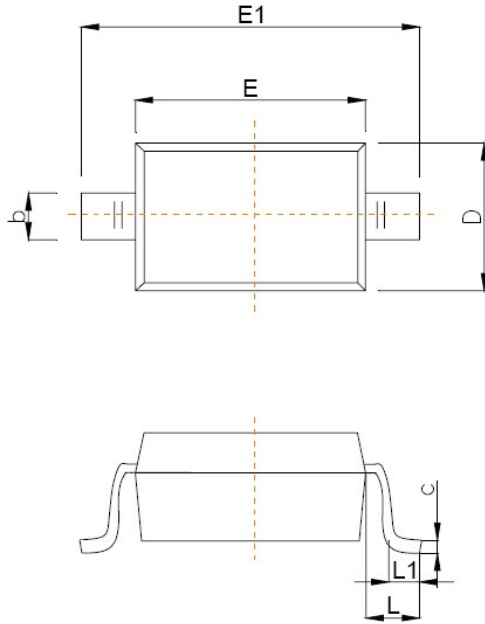
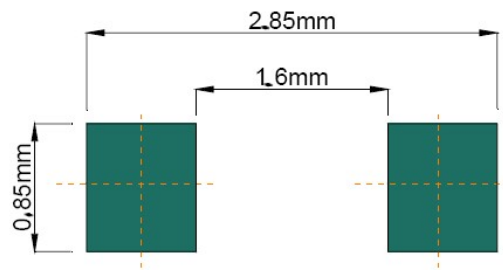

Fig 4 Peak Pulse Current vs Clamping Voltage



**SOD-323 PACKAGE OUTLINE DIMENSIONS**

Symbol	Dimensions In Millimeters	
	Min	Max
A		1.00
A1	0.000	0.100
A2	0.800	0.900
b	0.250	0.350
c	0.080	0.150
D	1.200	1.400
E	1.600	1.800
E1	2.500	2.700
e	1.800	2.040
L	0.475 REF	
L1	0.250	0.400
$\theta$	0°	8°

**Recommended Pad outline**