

DESCRIPTION

The GSDxxC Series is designed for applications requiring transient overvoltage protection capability. They are intended for use in voltage and ESD sensitive equipment such as computers, printers, business machines, communication systems, medical equipment and other applications. These devices are ideal for situations where board space is at a premium.

This series has been specifically designed to protect sensitive components which are connected to power, data and transmission lines from overvoltage caused by ESD (electrostatic discharge), CDE (Cable Discharge Events), and EFT (electrical fast transients).

ORDERING INFORMATION

- ◇ Device: GSDxxC
- ◇ Package: SOD-323
- ◇ Material: Halogen free and RoHS compliant
- ◇ Packing: Tape & Reel
- ◇ Quantity per reel: 3,000pcs

PIN CONFIGURATION

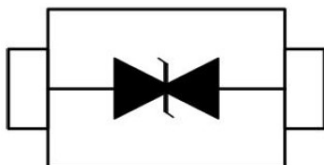

FEATURES

- ◇ IEC61000-4-2 (ESD) $\pm 30\text{kV}$ (Contact)
 $\pm 30\text{kV}$ (Air)
- ◇ IEC61000-4-4 (EFT) 40A (5/50ns)
- ◇ 350 Watts Peak Pulse Power per (tp=8/20 μs)
- ◇ Protects one I/O line (bidirectional)
- ◇ Low clamping voltage
- ◇ Working voltages:
3V, 5V, 8V, 12V, 15V, 18V, 20V, 24V, 36V
- ◇ Low leakage current

MACHANICAL DATA

- ◇ SOD-323 package
- ◇ Flammability Rating: UL 94V-0
- ◇ Packaging: Tape and Reel
- ◇ High temperature soldering guaranteed:
260°C/10s
- ◇ Reel size: 7 inch
- ◇ MSL 1

APPLICATIONS

- ◇ Cell Phone Handsets and Accessories
- ◇ Microprocessor based equipment
- ◇ Personal Digital Assistants (PDA's)
- ◇ Notebooks, Desktops, and Servers
- ◇ Portable Instrumentation
- ◇ Networking and Telecom
- ◇ Serial and Parallel Ports.
- ◇ Peripherals

PACKAGE OUTLINE



ABSOLUTE MAXIMUM RATING

Symbol	Parameter	Value	Units
V_{ESD}	ESD per IEC 61000-4-2 (Contact)	±30	kV
	ESD per IEC 61000-4-2 (Air)	±30	
P_{PP}	Peak Pulse Power (8/20μs)	350	W
T_{OPT}	Operating Temperature	-55/+150	°C
T_{STG}	Storage Temperature	-55/+150	°C
T_L	Lead Soldering Temperature	260 (10 sec.)	°C

ELECTRICAL CHARACTERISTICS (Tamb=25°C)

PART NUMBER	DEVICE MARKING	V_{RWM} (V) (max.)	V_B (V) (min.)	I_T (mA)	$V_C@1A$ (V) (max.)	V_C (V)		I_R (μA) (max.)	C_T (pF) (max.)
						(max.)	(@A)		
GSD03C	2A	3.3	4.0	1	7.5	16.0	20	40	450
GSD05C	2B	5.0	6.0	1	9.8	18.0	17	10	200
GSD08C	2C	8.0	8.5	1	13.4	24.0	15	2	120
GSD12C	2D	12.0	13.3	1	19.0	32.0	11	1	75
GSD15C	2J	15.0	16.7	1	24.0	38.0	10	1	68
GSD18C	2K	18.0	20.0	1	29.0	45.0	9	1	57
GSD20C	2L	20.0	22.3	1	35.0	50.0	8	1	52
GSD24C	2H	24.0	26.7	1	43.0	52.0	7	1	50
GSD36C	2N	36.0	40.0	1	60.0	75.0	4.5	1	35

ELECTRICAL CHARACTERISTICS CURVE

Fig 1 8/20 μ s Waveform per IEC61000-4-5

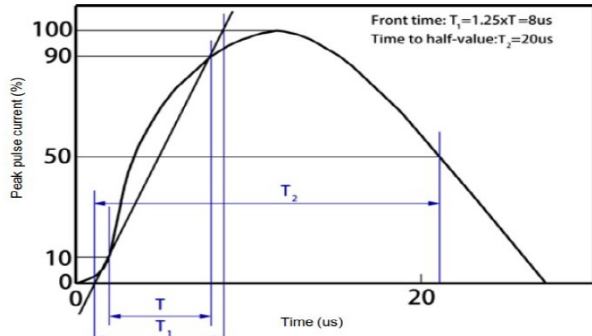

Fig 2 Contact Discharge Current Waveform per IEC 61000-4-2)

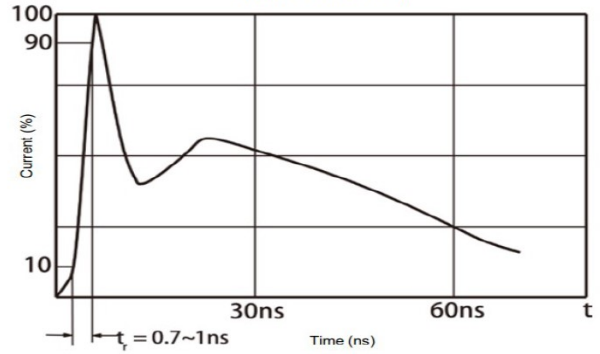

Fig 3 Voltage vs Capacitance

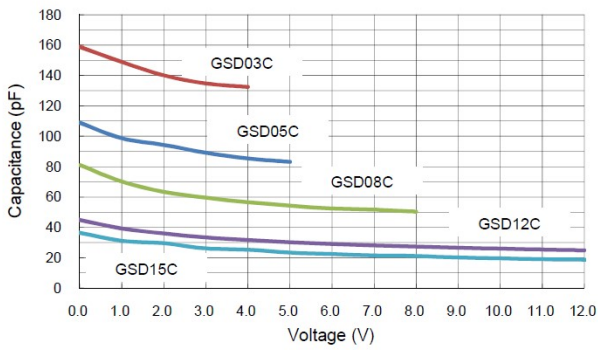

Fig 4 Voltage vs Capacitance

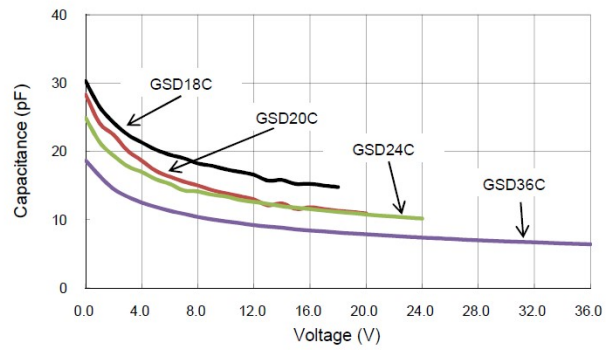

Fig 5 Clamping Voltage vs Peak Pulse Current

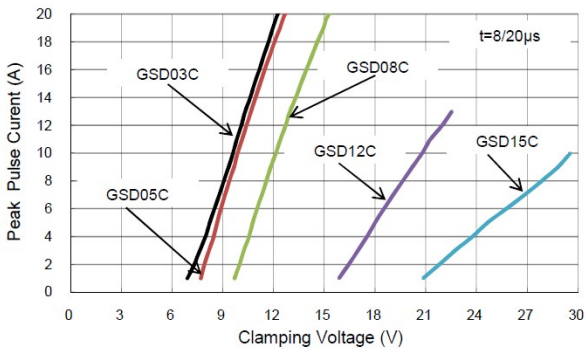
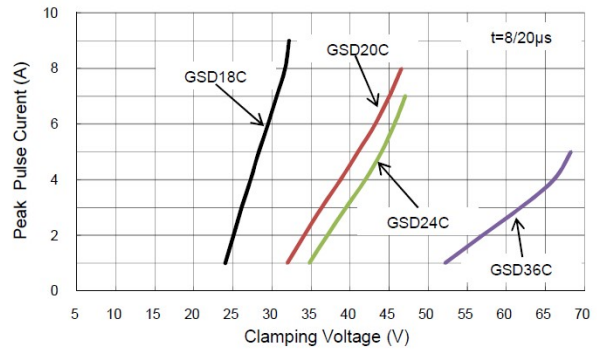
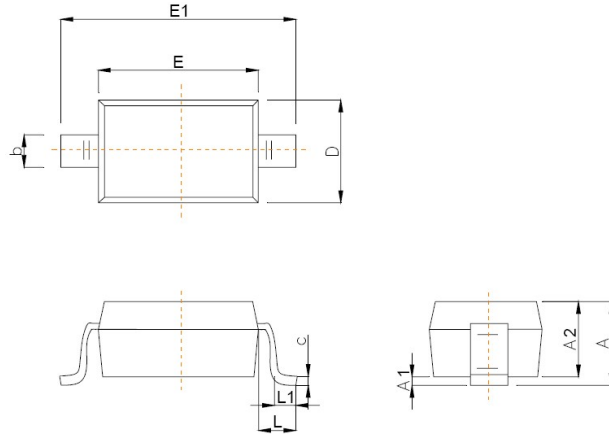

Fig 6 Clamping Voltage vs Peak Pulse Current



SOD-323 PACKAGE OUTLINE DIMENSIONS



Symbol	Dimensions In Millimeters	
	Min	Max
A		1.00
A1	0.000	0.100
A2	0.800	0.900
b	0.250	0.350
c	0.080	0.150
D	1.200	1.400
E	1.600	1.800
E1	2.500	2.700
e	1.800	2.040
L	0.475 REF	
L1	0.250	0.400
θ	0°	8°

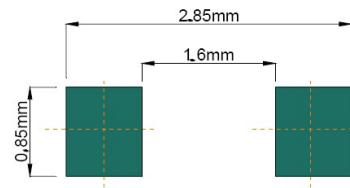

Recommended Pad outline