

Low Capacitance ESD/Surge Protection for Gigabit Ethernet Interfaces

DESCRIPTION

GESD2201-33 is a low-capacitance Transient Voltage Suppressor (TVS) array designed to provide electrostatic discharge (ESD) protection for high-speed data interfaces. With typical capacitance of 3.8pF only, GESD2201-33 is designed to protect parasitic-sensitive systems against over-voltage and over-current transient events. It complies with IEC 61000-4-2 (ESD), Level 4 ($\pm 15\text{kV}$ air, $\pm 8\text{kV}$ contact discharge), IEC 61000-4-4 (electrical fast transient - EFT) (40A, 5/50 ns), IEC 61000-4-5 (Surge) (25A, 8/20 μs), very fast charged device model (CDM) ESD and cable discharge event (CDE), etc.

GESD2201-33 is in a DFN2.6 \times 2.6-10L package. Each GESD2201-33 device can protect two high-speed line pairs. The combined features of low capacitance and high ESD robustness make GESD2201-33 ideal for high-speed data port and high-frequency line (e.g., Gigabit Ethernet Ports) applications. The low clamping voltage of the GESD2201-33 guarantees a minimum stress on the protected IC.

ORDERING INFORMATION

- ✧ Device: GESD2201-33
- ✧ Package: DFN2.6*2.6-10L
- ✧ Marking: part number, date code
- ✧ Material: Halogen free
- ✧ Packing: Tape & Reel
- ✧ Quantity per reel: 3,000pcs

PIN CONFIGURATION

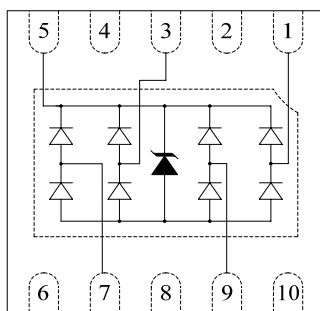

FEATURES

- ✧ Transient protection for high-speed data lines
 - IEC 61000-4-2 (ESD) $\pm 15\text{kV}$ (Air)
 - $\pm 8\text{kV}$ (Contact)
 - IEC 61000-4-4 (EFT) 40A (5/50 ns)
 - IEC 61000-4-5 (Surge) 25A (8/20 μs)
- ✧ Package optimized for high-speed lines
- ✧ Provides protection for two line pairs
- ✧ Low capacitance: 3.8pF @ 0V (Typical)
- ✧ Low leakage current: 0.1 μA @ VRWM (Typical)
- ✧ Low operating and clamping voltage
- ✧ Each I/O pin can withstand over 1000 ESD strikes for $\pm 8\text{kV}$ contact discharge

MACHANICAL DATA

- ✧ DFN2.6*2.6-10L package
- ✧ Flammability Rating: UL 94V-0
- ✧ MSL 1 & Thermally-Enhanced
- ✧ Flow-Through
- ✧ Packaging: Tape and Reel
- ✧ Reel size: 7 inch
- ✧ High temperature soldering guaranteed: 260 $^{\circ}\text{C}$ /10s

APPLICATIONS

- ✧ 10/100/1000M Ethernet Ports
- ✧ WAN/LAN Equipment
- ✧ Desktops, Servers and Notebooks
- ✧ Cellular Phones
- ✧ Switching Systems
- ✧ Audio/Video Inputs

CIRCUIT DIAGRAM

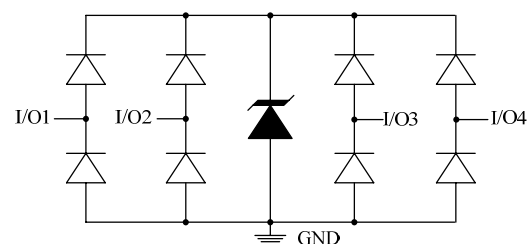

ABSOLUTE MAXIMUM RATING

Symbol	Parameter	Value	Units
P_{PP}	Peak Pulse Power (8/20 μ s)	450	W
I_{PP}	Peak Pulse Current (8/20 μ s)	25	A
V_{ESD}	ESD per IEC 61000-4-2 (Air) ESD per IEC 61000-4-2 (Contact)	± 25 ± 15	kV
T_{OPT}	Operating Temperature	-55/+125	$^{\circ}$ C
T_{STG}	Storage Temperature	-55/+150	$^{\circ}$ C

ELECTRICAL CHARACTERISTICS ($T_{amb}=25^{\circ}$ C)

Symbol	Parameter	Test Condition	Min	Typ	Max	Units
V_{RWM}	Reverse Working Voltage				3.3	V
I_R	Reverse Leakage Current	$V_{RWM} = 3.3V$ Any I/O pin to GND		0.1	1.0	μ A
V_{t1}	Trigger Voltage	$I_{t1} = 1\mu A$ Any I/O pin to GND	3.5	4.2	5.0	V
V_h	Holding Voltage	$I_h = 1mA$ Any I/O pin to GND	3.3		4.5	V
V_{C1}	Clamping Voltage 1	$I_{PP} = 1A, t_p = 8/20\mu s$ Any I/O pin to GND			5.5	V
V_{C2}	Clamping Voltage 2	$I_{PP} = 10A, t_p = 8/20\mu s$ Any I/O pin to GND			8.5	V
V_{C3}	Clamping Voltage 3	$I_{PP} = 25A, t_p = 8/20\mu s$ Any I/O pin to GND			16.0	V
C_{J1}	Junction Capacitance 1	$V_R = 0V, f = 1MHz$ Any I/O pin to GND		3.8	5.0	pF
C_{J2}	Junction Capacitance 2	$V_R = 0V, f = 1MHz$ Between I/O pins		2.0	2.5	pF

ELECTRICAL CHARACTERISTICS CURVE

8/20µs Pulse Waveform

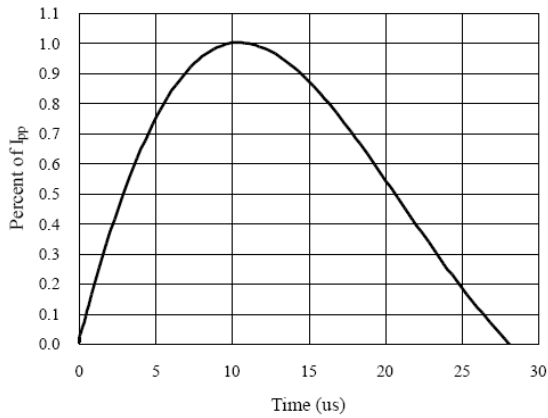

Clamping Voltage V_C vs. Current I_{PP}

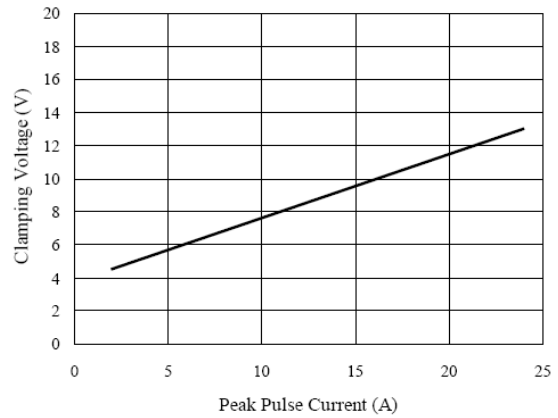

Insertion Loss S21

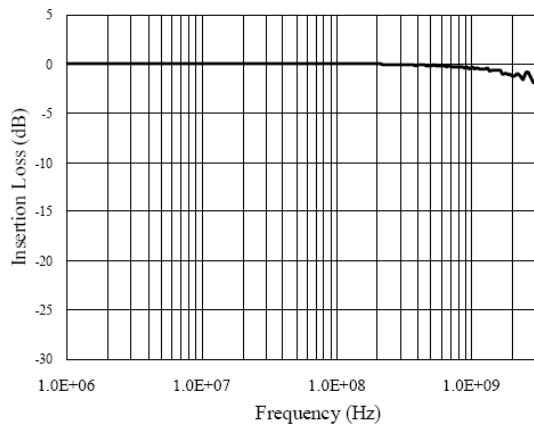

Normalized Capacitance vs. Voltage

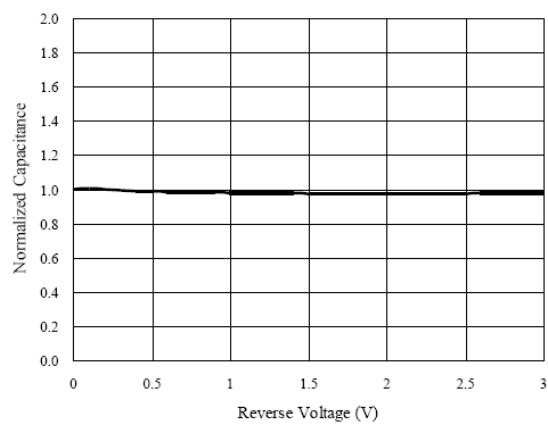

ESD Clamping of I/O to GND
(+8kV Contact per IEC 61000-4-2)

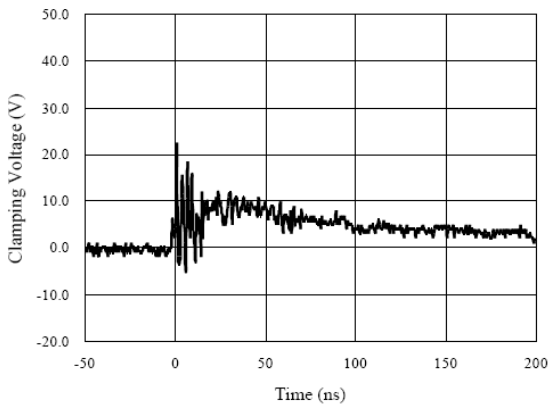

ESD Clamping of I/O to GND
(-8kV Contact per IEC 61000-4-2)

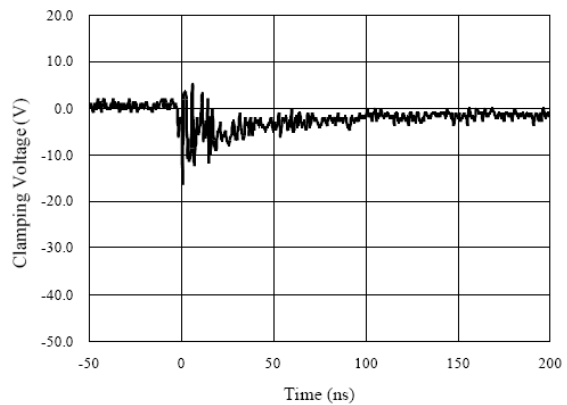

DFN2.6*2.6-10L PACKAGE OUTLINE DIMENSIONS

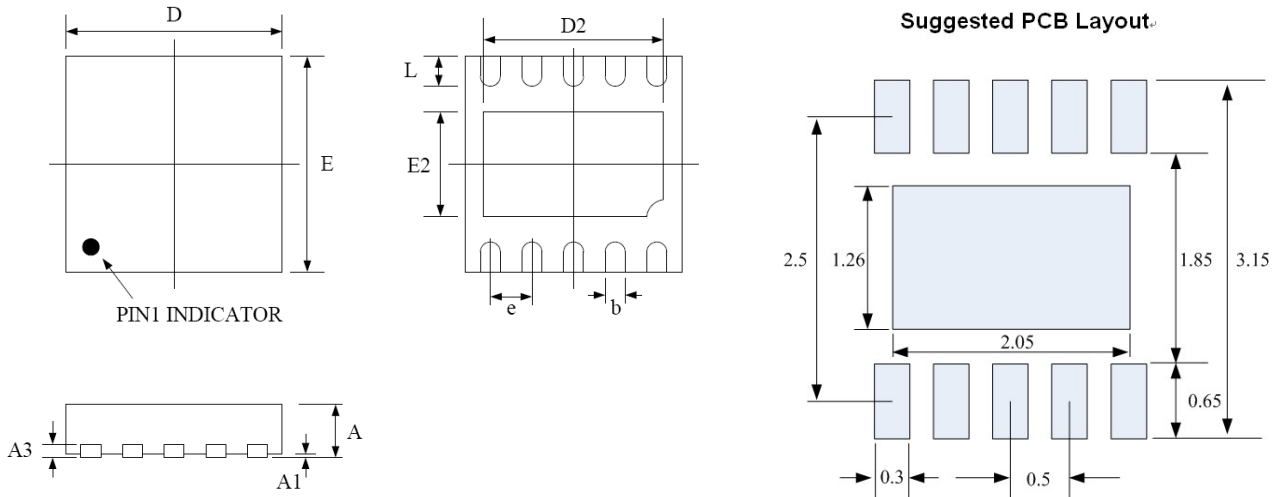

Package Dimensions (Controlling dimensions are in millimeters)

Symbol	Dimensions (mm)			Dimensions (Inches)		
	Minimum	Typical	Maximum	Minimum	Typical	Maximum
A	0.500	0.550	0.600	0.020	0.022	0.024
A1	0.000	—	0.050	0.000	—	0.002
A3	0.15 REF			0.006 REF		
b	0.200	0.250	0.300	0.008	0.010	0.012
D	2.550	2.600	2.650	0.100	0.102	0.104
D2	2.000	2.150	2.250	0.079	0.085	0.089
e	0.500 BSC			0.020 BSC		
E	2.550	2.600	2.650	0.100	0.102	0.104
E2	1.110	1.260	1.360	0.044	0.050	0.054
L	0.250	0.350	0.450	0.010	0.014	0.018