

### Surface Mount Superfast Recovery Rectifier

Reverse Voltage – 50 to 600 V

Forward Current – 3 A

#### FEATURES

- For surface mounted applications
- Low profile package
- Glass Passivated Chip Junction
- Superfast reverse recovery time
- Lead free in comply with EU RoHS 2011/65/EU directives

#### MECHANICAL DATA

- Case: SMA
- Terminals: Solderable per MIL-STD-750, Method 2026
- Approx. Weight: 0.055g / 0.002oz

#### PINNING

PIN	DESCRIPTION
1	Cathode
2	Anode

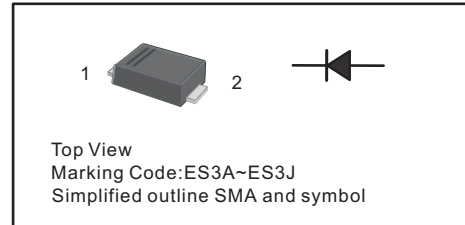

#### Absolute Maximum Ratings and Characteristics

Ratings at 25 °C ambient temperature unless otherwise specified. Single phase, half wave, 60 Hz, resistive or inductive load. For capacitive load, derate current by 20%.

Parameter	Symbols	ES3A	ES3B	ES3C	ES3D	ES3E	ES3G	ES3J	Units
Maximum Repetitive Peak Reverse Voltage	$V_{RRM}$	50	100	150	200	300	400	600	V
Maximum RMS voltage	$V_{RMS}$	35	70	105	140	210	280	420	V
Maximum DC Blocking Voltage	$V_{DC}$	50	100	150	200	300	400	600	V
Maximum Average Forward Rectified Current at $T_c = 125\text{ }^\circ\text{C}$	$I_{F(AV)}$	3							A
Peak Forward Surge Current 8.3 ms Single Half Sine Wave Superimposed on Rated Load	$I_{FSM}$	80							A
Maximum Forward Voltage at 3 A	$V_F$	1				1.25		1.68	V
Maximum DC Reverse Current at Rated DC Blocking Voltage $T_a = 25\text{ }^\circ\text{C}$ $T_a = 125\text{ }^\circ\text{C}$	$I_R$	5 100							$\mu\text{A}$
Typical Junction Capacitance at $V_R=4\text{V}$ , $f=1\text{MHz}$	$C_j$	40							pF
Maximum Reverse Recovery Time <sup>(1)</sup>	$t_{rr}$	35							ns
Typical Thermal Resistance <sup>(2)</sup>	$R_{\theta JA}$ $R_{\theta JC}$	50 16							$^\circ\text{C/W}$
Operating and Storage Temperature Range	$T_j, T_{stg}$	-55 ~ +150							$^\circ\text{C}$

(1) Measured with  $I_F = 0.5\text{ A}$ ,  $I_R = 1\text{ A}$ ,  $I_{rr} = 0.25\text{ A}$ .

(2) P.C.B. mounted with 2.0" X 2.0" (5 X 5 cm) copper pad areas.

**Fig.1 Reverse Recovery Time Characteristic And Test Circuit Diagram**

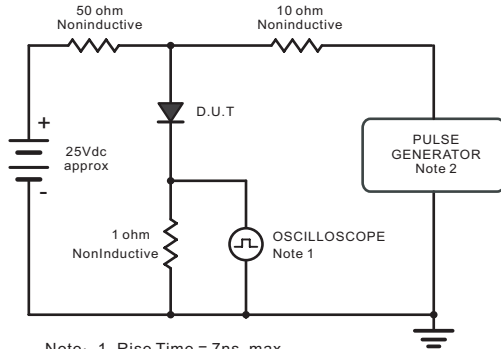

Note: 1. Rise Time = 7ns, max.  
Input Impedance = 1 megohm, 22pF.  
2. Rise Time = 10ns, max.  
Source Impedance = 50 ohms.

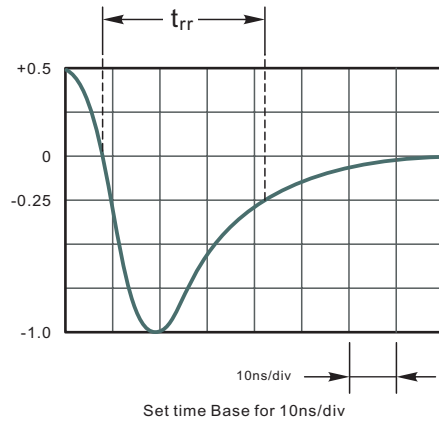

**Fig.2 Maximum Average Forward Current Rating**

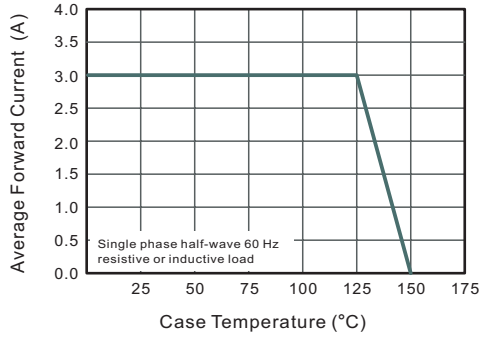

**Fig.3 Typical Reverse Characteristics**

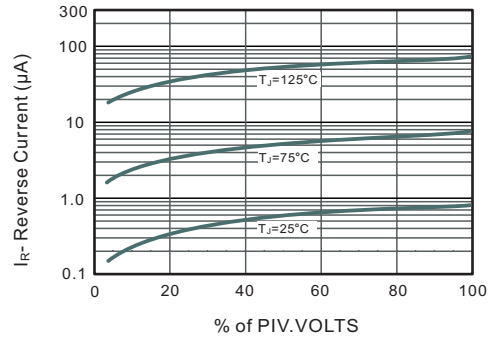

**Fig.4 Typical Forward Characteristics**

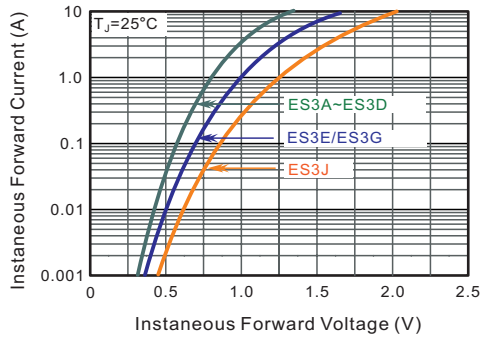

**Fig.5 Typical Junction Capacitance**

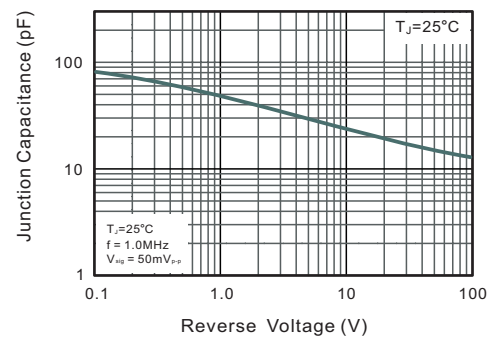

**Fig.6 Maximum Non-Repetitive Peak Forward Surge Current**

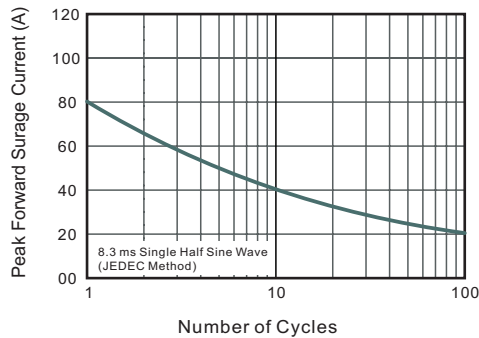

### PACKAGE OUTLINE

Plastic surface mounted package; 2 leads

SMA

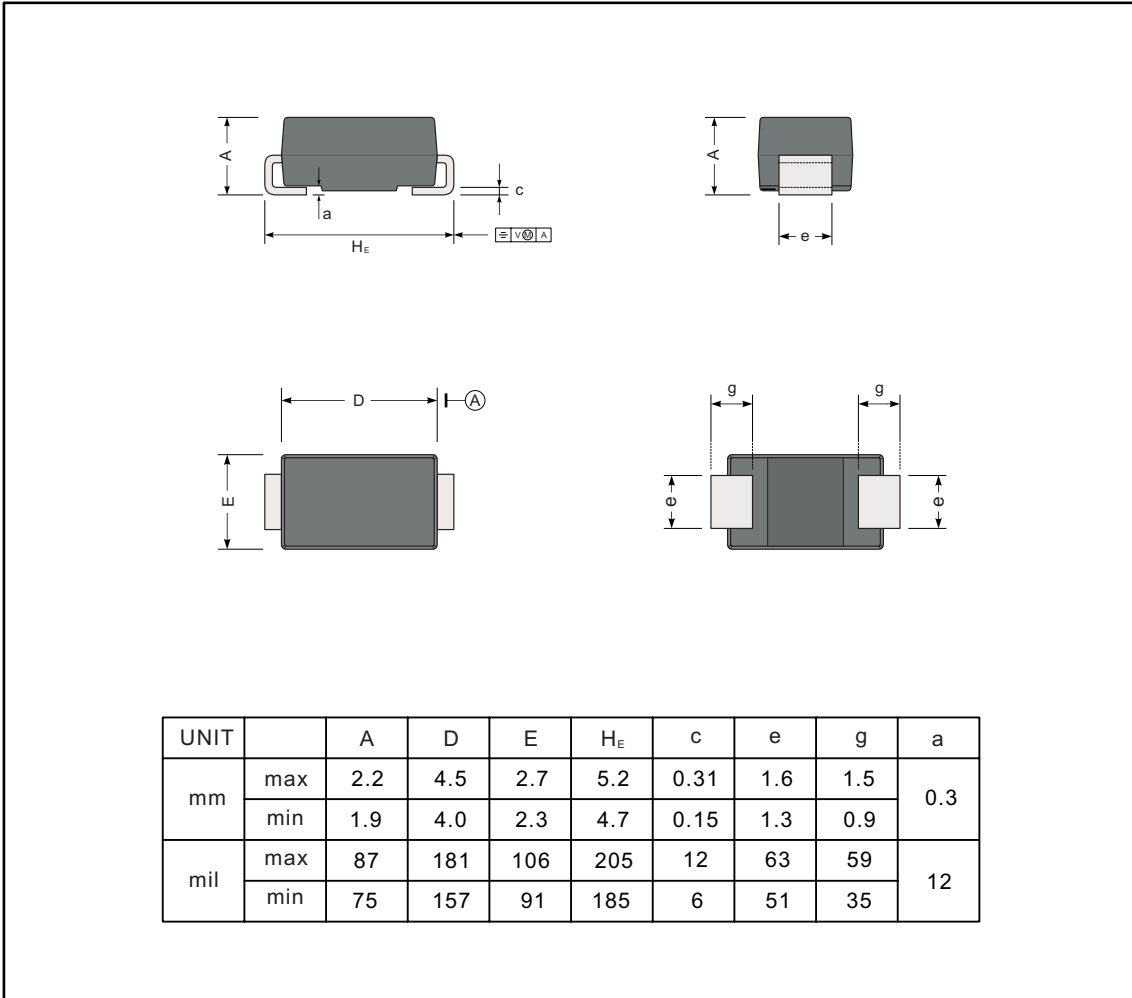

### The recommended mounting pad size

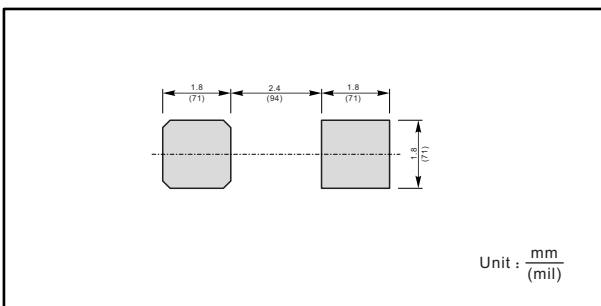

### Marking

Type number	Marking code
ES3A	ES3A
ES3B	ES3B
ES3C	ES3C
ES3D	ES3D
ES3E	ES3E
ES3G	ES3G
ES3J	ES3J