

Surface Mount Schottky Barrier Rectifier

Surface Mount Schottky Barrier Rectifier

Reverse Voltage - 100 V

Forward Current - 3.0A

Features

- Metal silicon junction, majority carrier conduction
- For surface mounted applications
- Low power loss, high efficiency
- High forward surge current capability
- For use in low voltage, high frequency inverters, free wheeling, and polarity protection applications

MECHANICAL DATA

- Case: SMBF
- Terminals: Solderable per MIL-STD-750, Method 2026
- Approx. Weight: 57mg / 0.002oz

PINNING

PIN	DESCRIPTION
1	Cathode
2	Anode

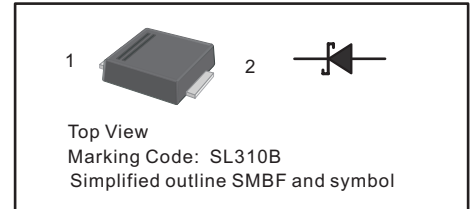

Absolute Maximum Ratings and Electrical characteristics

Ratings at 25 °C ambient temperature unless otherwise specified. Single phase, half wave, 60Hz resistive or inductive load, for capacitive load, derate by 20 %

Parameter	Symbols	SSL310BF	Units
Maximum Repetitive Peak Reverse Voltage	V_{RRM}	100	V
Maximum RMS voltage	V_{RMS}	70	V
Maximum DC Blocking Voltage	V_{DC}	100	V
Maximum Average Forward Rectified Current	$I_{F(AV)}$	3.0	A
Peak Forward Surge Current, 8.3ms Single Half Sine-wave Superimposed on Rated Load (JEDEC method)	I_{FSM}	100	A
Max Instantaneous Forward Voltage at 3 A	V_F	0.6	V
Maximum DC Reverse Current at Rated DC Reverse Voltage $T_a = 25^{\circ}C$	I_R	0.1	mA
Typical Junction Capacitance ⁽¹⁾	C_j	180	pF
Typical Thermal Resistance ⁽²⁾	$R_{\theta JA}$	65	$^{\circ}C/W$
Operating Junction Temperature Range	T_j	-55 ~ +150	$^{\circ}C$
Storage Temperature Range	T_{stg}	-55 ~ +150	$^{\circ}C$

(1) Measured at 1 MHz and applied reverse voltage of 4 V D.C

(2) P.C.B. mounted with 2.0" X 2.0" (5 X 5 cm) copper pad areas.

Fig.1 Forward Current Derating Curve

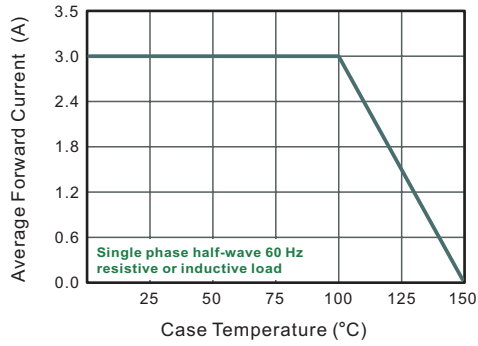

Fig.2 Typical Reverse Characteristics

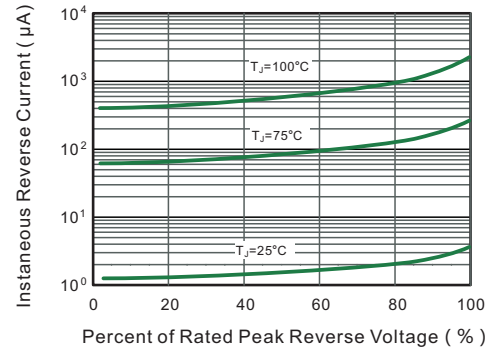

Fig.3 Typical Forward Characteristic

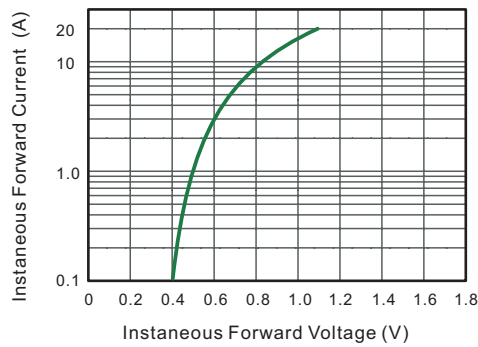

Fig.4 Typical Junction Capacitance

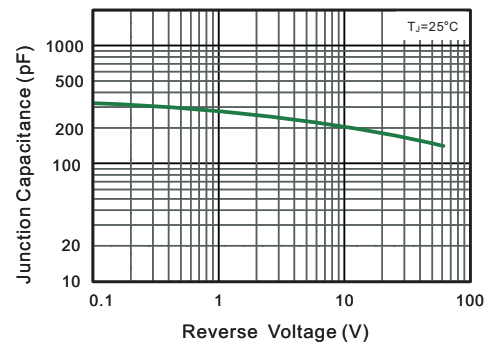

Fig.5 Maximum Non-Repetitive Peak Forward Surge Current

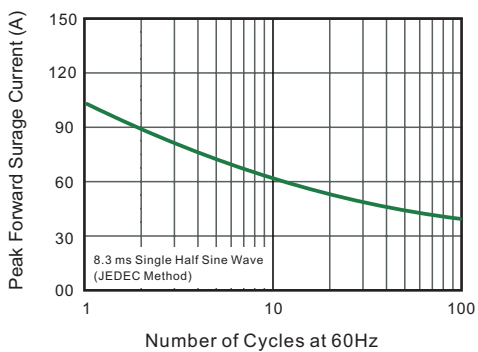
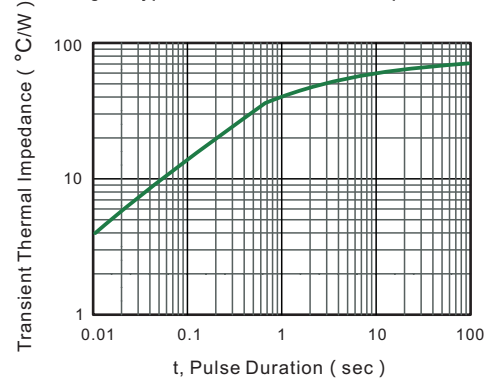

Fig.5- Typical Transient Thermal Impedance



PACKAGE OUTLINE

Plastic surface mounted package; 2 leads

SMBF

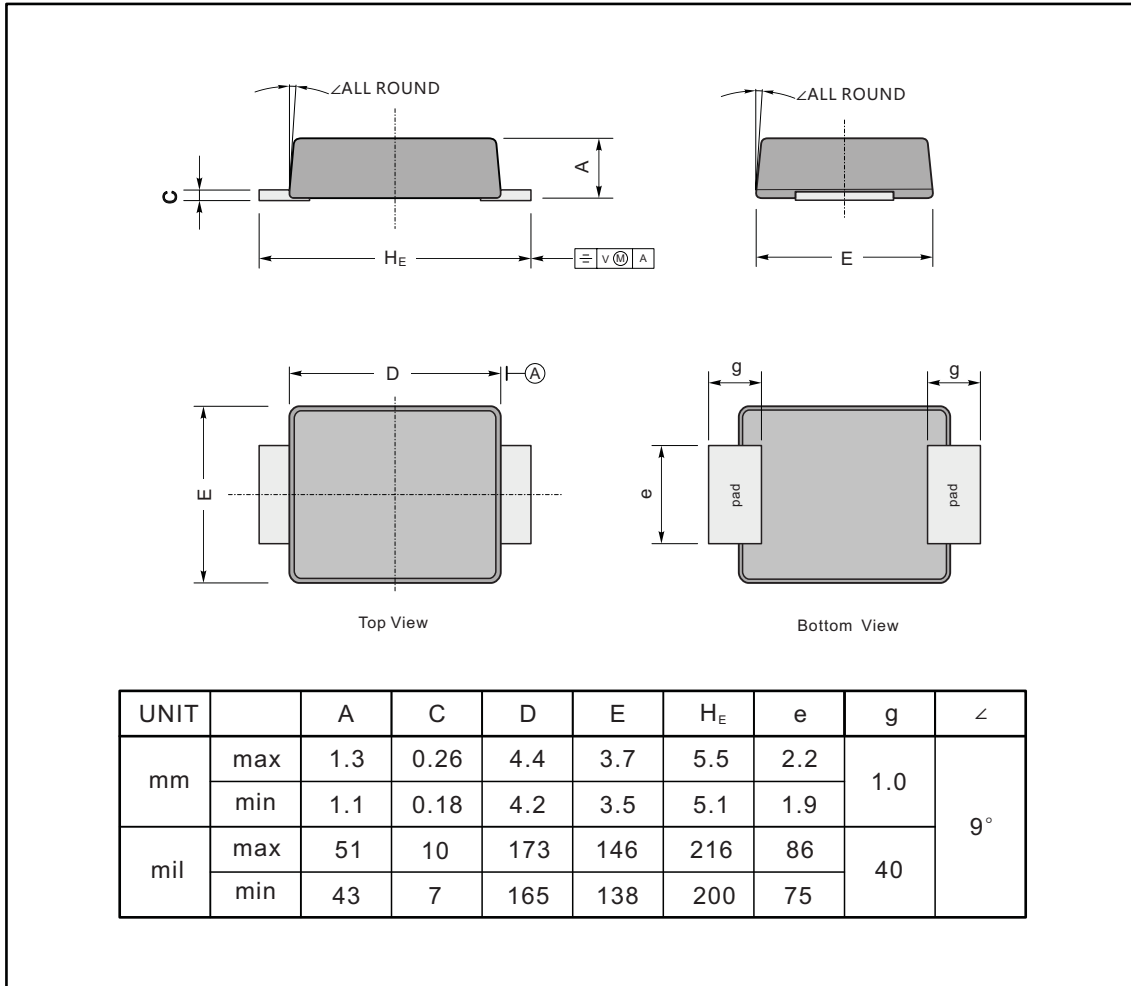

The recommended mounting pad size

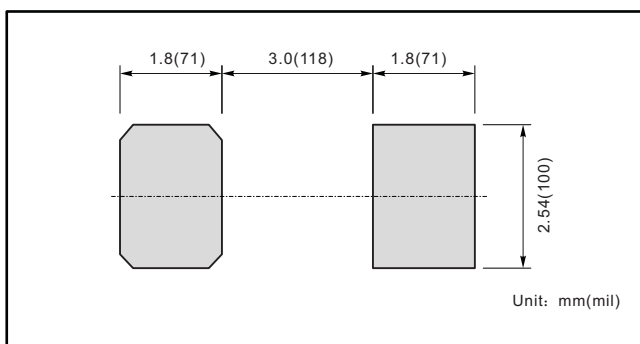

Marking

Type number	Marking code
SSL310BF	SL310B